

Document No.:

JPLM-001/15

Rev. No.:

12

Date:

01.10.2018

# JETT PLASMA LIFT MEDICAL

## Instruction for Use

CE 0123



Prior to putting the JETT PLASMA LIFT MEDICAL device into operation, be so kind and read these instructions carefully and thoroughly. Observe all cautions and warnings contained herein.

Manufactured by the company **COMPEX, spol. s r.o.** in the Czech Republic

## LIST OF CONTENTS

1.	General information.....	3
2.	Pack contents.....	4
2.1	Standard content of a pack.....	4
2.2	Optional accessories.....	7
3.	Purpose of use.....	10
3.1	Ablative treatment.....	10
3.2	Non ablative treatment.....	11
3.3	Results before and after treatment.....	12
3.4	Description of function.....	12
3.4.1	Principle of discharge generation.....	13
3.4.2	Action on the skin during ablative treatment.....	13
3.4.3	Action on the skin during non ablative treatment.....	14
3.5	Indications and contraindications.....	15
3.5.1	Indications.....	15
3.5.2	Contraindications.....	16
3.5.3	Possible side effects.....	16
4.	Warnings and precautions.....	17
4.1	Introductory precautions.....	17
4.2	Error messages on device display.....	18
4.3	Warnings and precautions following from use of the device.....	18
5.	Device control.....	21
5.1	Symbols on the cover of the device, on the device itself and on accessories.....	28
6.	Basic characteristics.....	29
7.	Service life.....	30
8.	Storage, maintenance and safety technical inspections.....	30
8.1	Storage.....	30
8.2	Regular maintenance and cleaning.....	30
8.2.1	Disinfection.....	31
8.2.2	Sterilization.....	31
8.3	Safety technical inspections.....	31
8.4	Product retirement and disposal.....	31
9.	Servicing.....	32
10.	Warranty.....	32
11.	EMC.....	32
11.1	Electromagnetic interference.....	32
11.2	Electromagnetic emissions.....	33
11.3	Electromagnetic immunity.....	33
12.	Rating plate of the device.....	34
13.	Rating plate of accessories.....	35
14.	List of Annexes.....	38

## 1. General information

Prior to using the JETT PLASMA LIFT MEDICAL device, you must read, understand and follow all the safety and security precautions described in this Instruction for Use. Observe all safety instructions during the treatment. Be all the time advised about appropriate indications and contraindications, when using the JETT PLASMA LIFT MEDICAL device.

The JETT PLASMA LIFT MEDICAL device may be operated only by the physician provably trained by the manufacturer or the authorized distributor or by the person who may work with the medical devices in conformity with the national legislation and treat the indications shown in sec. 3.5.1, within the scope of the Instruction for Use, who has been familiarized well with the commonly known risks and with the benefits and contributions of stimulating the treated area by a plasma discharge. This trained person may further train other physicians or medical staff within his/her workplace in accordance with the national legislation. Disinfection and sterilization of the device and its accessories may also be performed by a nurse trained by a physician. A written record must be kept about each passed training. Treatment in natural body cavities and ophthalmic indications may be performed by a physician only.





JETT PLASMA LIFT MEDICAL is a low-power portable DC electrocauter. It is a medical device designed for dermatological and ophthalmic interventions, which works on the physical principle of sequence of the spark discharges with the generation of plasma.



Prior to first putting the device into operation or after change of the working environment, the *TAPÉ* calibration has to be performed (see sec. 5 – *TAPÉ* calibration for more information)!

2. Pack contents

2.1 Standard content of a pack

<p><b>JETT PLASMA LIFT MEDICAL device itself with a cone applicator</b></p>	
<p><b>Instruction for Use</b></p>	
<p><b>Network adapter with relevant end piece</b></p>	
<p><b>golden applicator</b></p>	
<p><b>flat applicator</b>, intended solely for non ablativ treatment</p>	

**flat applicator, diameter 3 mm**, intended solely for non ablative treatment



**flat applicator, diameter 5 mm**, intended solely for non ablative treatment



**extension cable for the network adapter**



**Curly connection cable** for disposable electrodes with a 22 k $\Omega$  protective resistor allowing galvanic connection of the patient with the device

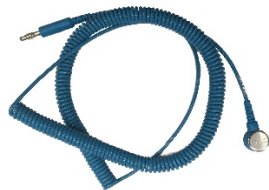

**Curly connection cable** for cylinder electrodes with a 22 kΩ protective resistor allowing galvanic connection of the patient with the device



**cylinder electrode**



**20 pcs of disposable CE electrodes**  
4 pcs of electrodes in a pack  
HRTR59BP  
50x94 mm



2.2 Optional accessories

**head with isolated applicator L44**









**head with isolated applicator L64**



**head with isolated applicator L84**



<p><b>Plasma Pen</b></p>	
<p><b>golden applicator 14.4 mm</b> intended for the Plasma Pen</p>	
<p><b>golden applicator 24.4 mm</b> intended for the Plasma Pen</p>	
<p><b>cone applicator</b> intended for the Plasma Pen, only and exclusively for non ablative treatment</p>	
<p><b>flat applicator, diameter 3 mm</b>, intended for the Plasma Pen, only and exclusively for non ablative treatment</p>	
<p><b>flat applicator, diameter 5 mm</b>, intended for the Plasma Pen, only and exclusively for non ablative treatment</p>	



**flat applicator, diameter 10 mm**, intended for the Plasma Pen, only and exclusively for non ablative treatment



**flat applicator, diameter 20 mm**, intended for the Plasma Pen, only and exclusively for non ablative treatment



**ophthalmology applicator** intended for the Plasma Pen



**isolated applicator L44** intended for the Plasma Pen



**isolated applicator L64** intended for the Plasma Pen



**Stand 1**



## Stand 2

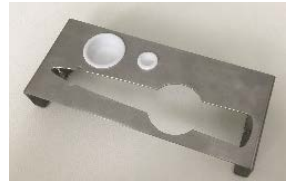

**THE DEVICE MAY BE USED WITH ORIGINAL ACCESSORIES ONLY PROVIDED BY THE MANUFACTURER!!!**

### 3. Purpose of use

JETT PLASMA LIFT MEDICAL is the medical device intended, based on the physical principle of a sequence of spark discharges generated by DC voltage, to treat skin and mucous membranes. The device can also be used to eliminate scars, smaller warts, fibromas, hemangiomas and unwanted skin formations, angiectases, keratoses, etc. Some of these indications can be treated, using heads with isolated applicators or isolated applicators themselves even inside natural body cavities. Can also be used for treatment of eye diseases, see sec. 3.5.1.

The product is intended for dermatological and ophthalmic interventions listed above. It is the reusable medical device marketed in a non-sterile state. The purpose is to correct or eliminate miscellaneous skin formations, minor tumours and deformities using spark discharges generated by DC voltage.

The indications as above are of medical character. The indications below are specified as cosmetic indications (not included in the conformity assessment process):

- acne,
- enlarged venules,
- spider naevi,
- pigmented spots,
- old age (pigmented) spots,
- shallow and deep wrinkles.

### 3.1 Ablative treatment

For ablative treatments, high spark discharge intensities (6-8) are used, where the phenomena of electrofulguration, electrodesiccation and electrocoagulation do occur. These intensities already destroy the skin cells and are used successfully, for example, to remove venules and minor benign tumours. The spark discharge is also carrier of the thermal energy, and when the device applicator tip approaches approximately to 0.5-4 mm, the applicator tip can generate the temperature up to 80°C on the skin. These phenomena are used purposefully during the following ablative treatments:

- stop minor capillary bleeding,
- elimination of scars and minor warts,
- elimination of hemangiomas (benign mesenchymal blood vessel tumours) and small venectases,
- elimination of undesirable skin formations - fibromas,
- deep wrinkles.

The list of all indications can be found in sec. 3.5.1 Indications. The treating physician always determines the number of treatments.

The plasma channel generated by the DC excitation voltage is very narrow (ca 1 mm<sup>2</sup>), and, thanks to it, skin treatment and eventual targeted skin cell destruction is very accurate. The device can be used to treat surface of the body as well as the skin and mucous membranes inside the oral, nasal, genito-anal areas and the zone round the eyes.

#### *Example of treatment (desiccation, fulguration, coagulation)*

In the course of ablative treatment, golden applicators are used and intensity of the spark discharge is set within 6-8. In this case, the physician applies (if necessary) a suitable anaesthetic on the patient's skin, disinfected with a suitable disinfectant, and then initiates the treatment itself, where the sequence of spark discharges performs treatment of one of the indications shown in the Instruction for Use. During the skin treatment, the bar graph shows the efficiency of the spark discharge.

### 3.2 Non ablative treatment

In addition to medical indications, the JETT PLASMA LIFT MEDICAL device can also be used for cosmetic purposes (lifting, wrinkles and rejuvenation). For cosmetic purposes, silver applicators are used and intensities of 1-5 are applied. The spark discharge generates flow of negative electrons and positive ions. The discharge is generated by the direct current, with a negative charge at the device tip. The majority of cosmetic medicinal products contain negative ions, which can be incorporated into the skin very well thanks to polarization. The following indications, understood as non ablative treatment, are specified as cosmetic indications (not included in the conformity assessment process):

- acne – appropriate after discontinuation of the acute phase, for better scar healing and prevention,
- spider naevi,
- pigmented and old age spots,
- shallow wrinkles.

Result of the treatment is visible immediately. If the patient requires a longer lasting effect of the cosmetic application, the course of 6-8 treatments shall be passed in the following sequence:

There is a 3-day time interval between the first and second treatment, and it is necessary to extend the time interval for up to 1 week between each further treatment. After such a course of treatment, the effect will persist for up to half a year. It is then necessary to repeat the treatment according to the individual results. For sustained effect, we recommend to repeat the treatment once a month.

#### *Example of treatment - on the surface of the body*

In case of non-ablative treatment, intensity of the spark discharge is set in the range of 1-5. The treated spot must be cleaned properly. The treated site needs to be warmed thoroughly, causing collagen fibres to expand. Skin warm up can be done, using a warm mask or an intensive massage by applying a suitable cosmetic product, depending on the skin type. A uniform layer of conductive indifferent gel or a conductive layer of serum (e.g. Jett serum Liftvital) is applied on the treated site. Depending on the treated area, the necessary size of the flat applicator is

chosen. If a deep wrinkle has to be treated precisely, it is advisable to use a cone applicator. The device is switched on, when the applicator is in contact with the skin. The applicator is then moved directly on the skin. By applying the voltage, potential of the cell membranes is changed, intercellular channels are made passable and position of the ions is changed, which fact leads to the treated skin stretching.



In case of enlarged venule treatment, we do not warm the skin, because heat would enlarge the venules even more!

### 3.3 Results before and after treatment

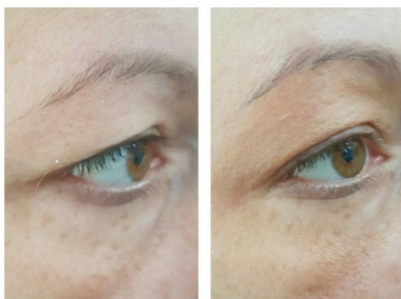

### 3.4 Description of function

The effects shown above are achieved by the sequence of spark discharges generated by DC voltage. The spark discharges generate heat that warms the skin. The DC fulguration (from Latin fulgur = lightning) was used for the first time in 1982 to ablate the AV node. The AC fulguration has been applied for many years already in high-frequency electrocautery for elimination of various skin artifacts or warts. The generated AC fulguration spark shower covers a large area of ca 1 cm<sup>2</sup>. The JETT PLASMA LIFT MEDICAL device uses the DC generated spark discharge, which has many advantages compared with AC fulguration:

- the discharge is very narrow (ca 1 mm<sup>2</sup>);
- skin treatment and targeted destruction of skin cells is very accurate;
- there is no damage to the surrounding tissue.

### 3.4.1 Principle of discharge generation

The device creates the spark discharge with plasma generation by applying the DC voltage of ca 5 kV with the maximum current of 1 mA. At a breakdown voltage of 5 kV between the tip of the device and the conductively connected patient's skin (to the device), the air containing the free electrons receives enough energy for breakdown. The air is ionized, becoming plasma and ceasing to be an insulator.

Plasma is the ionized gas consisting of ions and electrons, generated by electron disruption from the electron package of the gas atoms or by molecule rupture (ionization). The plasma can also be defined as the fourth state of matter.

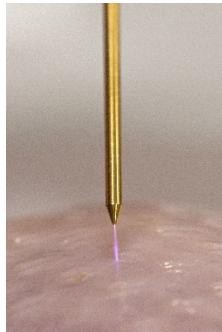

In our case, it is a quasi-neutral, low-temperature plasma with approximate equality of positively charged ions and negatively charged electrons. Plasma formation is an accompanying phenomenon of all electrical discharges in the ionized gas, including air.

Plasma is generated in all discharges of all existing electrocautery devices in the fulguration mode. This mode is also used by the JETT PLASMA LIFT MEDICAL device. It generates the plasma flow which, when acting on the biological tissues, triggers a specific response mechanism. This action of the plasma flux on the tissue allows to reach a very effective peeling, tissue renewal, strengthening, higher elasticity, and also to enhance tissue resistance and its defence.

### 3.4.2 Action on the skin during ablative treatment

1. Significant increase in concentration of type I collagen.
2. Reduction in the number of keloid fibroblasts in the area of the scars.
3. Increase in extracellular  $\text{Na}^+$  concentration.
4. Increase in intracellular  $\text{K}^+$  concentration.
5. Increase in chemotaxis.
6. Increase in growth factor level and increase in NO (nitric oxide) concentration.
7. Proved increase in migration of fibroblasts and their proteosynthesis.
8. Increase in skin permeability and reduction of the skin barrier function for penetration of the positively charged ions or water-soluble compounds.
9. New orientation of the newly generated or formed collagen fibres in the direction of the DC current.
10. Reduction in pain in the point of application, for example after injury, and accelerated healing.

Treatment of the skin by applying spark discharge is a completely natural phenomenon, where the desired effect occurs physiologically. No foreign chemicals are introduced into the skin.

**Electrofulguration** is application of an electric discharge, generated between the tip of the device and the skin of a patient at the distance of 2 mm. In our case, electrofulguration affects only a small area of the patient's skin thanks to generation of the spark discharge by the DC voltage.

**Electrodesiccation** is evaporation of cell liquids with subsequent destruction of cutaneous and subcutaneous cells. Evaporation is caused by the thermal energy generated by the oscillating spark discharge. A relatively low electric power is generated here, 1.8 W as a maximum which, by affecting a small area only, it is able to cause evaporation of the cell liquids.

**Electrocoagulation** is a process, where the thermal energy of the spark discharge causes evaporation of water in cells and disruption of their structure. High temperature results in coagulation of tissue and blood proteins, which is utilized for eliminating small bleeding, i.e. closing small veins of 2-3 mm diameter. The treated area is stimulated by a spark discharge with plasma generation; the application tip is 2 mm distant from the skin. The discharge is applied with a smaller power (1.8 W), compared to the classic electrocautery devices. With respect to the fact, that this power works in a very thin discharge beam and treats a small area only, a very good coagulation effect is reached locally.

Electrodesiccation, electrofulguration or electrocoagulation can be used for a number of indications in various medical fields. A detailed summary of applications will be the very subject of training, together with the handover of the device. The device can be used in classical surgery or dermatology and in other medical disciplines.

### 3.4.3 Action on the skin during non ablative treatment

Each cell has a membrane potential on its membrane (difference of electrical potential between two membrane sides). There is a negative charge on the inside of the cell membrane and the positive charge on the outside. Ageing of the skin results in uneven distribution of the electrical charge (potential) across the cell membrane and, thus in change of the electrical voltage of the membrane.

The membrane potential is generated and further affected by potassium and sodium cations, the sodium cations pass through the cell membrane with great problems only, while the potassium cations penetrate very easily.

The DC current, passing through the cells, leads to change in the membrane potential (membrane depolarization). Depolarization results in change of positions of individual types of ions and/or their passage through the membrane. By correctly distributing the ions on the inner and outer sides of the membrane, the membrane potential will again be stabilized. Electrical voltage of the cell membrane is increased and the membrane is stretched. If this process occurs in the majority of skin cells in a particular area, then skin stretching can be visible to the naked eye.

Before Use

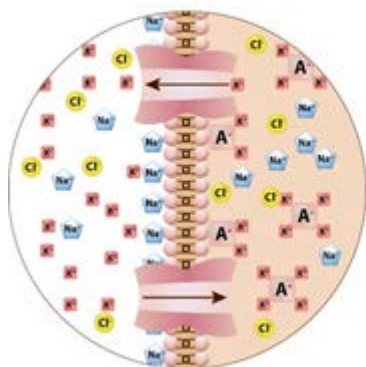

After Use

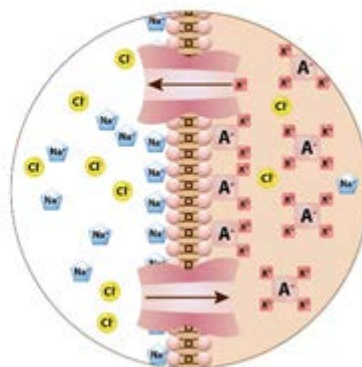

The electrocautery devices utilizing alternating current are unable to depolarize the membrane, because effects of the alternating current on the cell are either irritating, trophic or analgesic (the effect depends on the used frequency and intensity) and not depolarizing, because the alternating current is unable to pass through the cell membranes.

### 3.5 Indications and contraindications

#### 3.5.1 Indications

##### Benign vascular lesions

- angioma (hemangioma, naevus capillaris), teleangiectasia

##### Skin lesions

- keratosis (verruca seborrhoica, keratosis senilis, keratosis seborrhoica)
- keratoacanthoma
- fibroma
- xanthelasma

##### Infectious lesions

- verruca plana, verruca vulgaris
- condylomata accuminata
- molluscum contagiosum

##### Pigment changes (hyperpigmentation)

- melasma (chloasma)

##### Ophthalmology indications

- blepharitis;
- stenosis puncti lacrimalis;

- xanthelasma;
- trichiasis;
- distichiasis;
- ectropion;
- entropion.

If the heads with the isolated applicator or the isolated applicators are used, the indications as above can be treated even inside the natural body cavities (oral cavity, nasal cavity, rectum, vagina).

### 3.5.2 Contraindications

The trained operator is obliged to make sure provably that the patient to be treated does not suffer from any of the following contraindications, which fact is subject to recording (the Informed Consent is included as the integral part of this Instruction for Use):

- Peacemaker, Holter ECG monitoring system;
- Another implanted electrical device;
- Epilepsy;
- Pregnancy;
- Metal implants in the treated area;
- Skin diseases, skin inflammations;
- Acute inflammatory disease;
- Any untreated/badly treated disease;
- Oncological disease;
- Allergy to local anaesthetics;
- Allergy to disinfectants.

### 3.5.3 Possible side effects

Immediately after treatment, varying degrees of pain, rarely an allergic reaction to a disinfectant or a local anaesthetic may occur, in rare cases, weak erythema, congestion or swelling, scarring and pruritus as a result of healing can appear.

Like all treatments, this medical device can have side effects that may not happen to everyone.



When using the medical device JETT PLASMA LIFT MEDICAL, the following side effects may be experienced:

- Hyperpigmentation, which can be prevented by photoprotection after surgery. Skin is protected from sunlight by using SPF 50+ creams and by wearing sunglasses and headgear for at least 7-10 days after the procedure.
- Depigmentation that can be prevented by proper treatment after the intervention with healing creams to promote epithelization.
- Scars that can be prevented by proper treatment after the intervention with healing creams to promote epithelization, by photoprotection and silicone patches
- Feeling of metal in the mouth
- Tingling, where electrode is placed.



#### 4. Warnings and precautions

Safety instructions in this part of the Instruction for Use as well as in its other parts are marked with special symbols. Get familiar with these symbols and their explanations prior to start operating the device.

Symbol	Meaning
	<b>PRECAUTION</b> Covers possible safety risks that could cause minor or mid-size injury or a damage of the device.
	<b>WARNING</b> Describes possible safety risks that could result in imminent dangers and cause serious injuries or destruction of the device.

##### 4.1 Introductory precautions

Protect the device from falls and shocks to avoid damage of the device.

Do not use the accessories other than those delivered by the manufacturer.

All parts of the device must be connected in their designed precise positions.

Do not plug the device in greasy, smoky, humid or dusty environments and at the places where the device could get into the contact with water.

Follow the recommended treatment time and treatment method.

If a patient reports any unusual feelings during the treatment, interrupt the treatment immediately and contact the manufacturer!

If you ended use of the device and if you know that you will not use the product for a while, unplug it from the power supply (danger of fire).

Bend neither the supply cable nor other accessories by force and do not place any heavy or sharp things on them (danger of fire or electric shock).

Do not plug more electric cables or more device into one power source / socket (danger of fire).

Check the designed power source prior to plugging the device. If the power source other than recommended one is used, electric circuits can be damaged or fire ignited.

It is necessary to monitor effect of the plasma discharge continuously during the treatment. If any unexpected effect on the skin cells appears, the tip must be taken off the skin immediately and action of the plasma discharge on the skin cells must be interrupted at once.

Do not place the device, where its disconnection from the power supply source could be impossible.

Never leave the high voltage on unattended above the device applicator position, unwanted approach or touch could result in patient injury, fire or explosion of flammable vapours.

## 4.2 Error messages on device display

	<p><b>TAPE – patient-device interconnection</b></p> <p>The device is equipped with a reliable safety system SCS (Safety Control System), detecting whether or not the patient is connected with the device.</p> <p>For the whole time of treatment the patient must have the disposable electrode pasted on the hand or must hold the cylinder electrode in hand firmly. If the patient is not connected, the text “TAPE” is displayed and the high voltage source is disconnected automatically.</p>
	<p><b>TErr</b></p> <p>Two buttons are pushed simultaneously. Error of the operator, the text “TErr” appears.</p>
	<p><b>SrUc</b></p> <p>If a hardware error appears, the high voltage source will be switched off automatically and an error message “SrUc” appears. The device cannot be switched on anymore and must be sent to the manufacturer.</p>
	<p><b>TENP</b></p> <p>It is the thermal protection of the device. After 30 minutes of continuous discharge, the device will be switched off. The device can be reused again after a few minutes.</p>

## 4.3 Warnings and precautions following from use of the device

	<p><b>Original accessories</b></p> <p>Only original accessories from the manufacturer may be used with the device. When using the accessories other than the original ones (adapter, applicators, connection components), there is a risk of injury and destruction of the device.</p>
	<p><b>Correct treatment</b></p> <p>The trained operator may treat the permitted areas only (see the indications). It is permitted to use the device only within the scope of the Instruction for Use and training. Otherwise there is the risk of tissue damage and injury.</p>
	<p><b>Replacement of the applicator tip</b></p> <p>When replacing the applicator tip, the JETT PLASMA LIFT MEDICAL device must be disconnected demonstrably. Risk of burns by spark discharge.</p>
	<p><b>Plasma Pen</b></p> <p><b>If any damage anywhere on the connection cable (white can be seen) is revealed, it must be sent to the manufacturer.</b></p>
	<p><b>Work with network adapter</b></p> <p>Do not pull cable of the adapter by force and do not touch it with a wet hand. There is the risk of electric shock.</p>
	<p><b>General risks</b></p> <p>In case of a thunderstorm, lightning or earthquake, stop work with the device immediately and disconnect the power cord (risk of fire or electric shock).</p>



#### **Risk of explosion or fire**

Do not use the device in locations where flammable substances such as anaesthetics, alcohol, gas or solvents can be present. We recommend to use non-volatile compounds, if possible. If any volatile, flammable substance is used on the patient, then it is necessary to wait until possible flammable vapours are vented away.

Energy of the spark discharge is so high that it can ignite even other combustibles such as paper, textiles as well as oils or flammable creams (e.g. paraffin wax), etc., both on the patient and anywhere in the neighbourhood, if safe handling is not observed.



#### **Danger of electromagnetic interference**

Do not use the device in close proximity to other electronic and electrical devices as there is the risk of mutual electromagnetic interference.



#### **Danger of damage to skin**

At the set intensity (6, 7 or 8), the JETT PLASMA LIFT MEDICAL device damages the skin cells irreversibly. Use these intensities only where you want to destroy the skin cells purposefully (wart elimination). Be permanently aware that the device may destruct the skin cells at 6, 7 and 8 intensities, and be sure by a double check that you have set the correct intensity before each application. It means that if you use the non ablative treatment, where you do not destruct the skin cells purposefully, you may never set the intensity of 7 or 8, and it is also not recommended to adjust the intensity of 6 for treatments of this kind!



#### **Written approval, staff training**

**The device may be used only by demonstrably trained doctors or by the staff as permitted by the national legislation!**

Before each treatment, the trained staff must make sure that the patient does not suffer from any contraindication, and the informed consent must be filled in by the patient. Training of the operators is provided either by the manufacturer or by the authorized distributor. The trained staff receives a certificate authorizing its holder to work with JETT PLASMA LIFT MEDICAL device. The trained staff must make sure that no untrained person will work with the device in the workplace. The person trained by the manufacturer or by the distributor may train other persons on the relevant workplace.

**The trained staff must permanently follow the working procedures set by the manufacturer and must avoid the following safety risks:**



#### **Preparatory skin heating**

Temperature of the skin may not exceed 41°C, which shall be ensured by the trained staff by controlling the skin, using the touch thermometer.













#### **Skin protection from electric discharge**

In case of non ablative treatments (intensity of discharge 1-5), a sufficient layer of indifferent conductive gel must be applied on the skin. The application tip must be led by the trained operator in the application gel. After thorough consideration, the doctor can use a conductive serum instead of an indifferent conductive gel.



#### **Treatment close to the eyes and treatment using a sharp tip**

It is necessary to perform treatment, using a sharp tip (cone applicator, golden applicator, head with isolated applicator L44/L64/L84, applicators for Plasma Pen: cone applicator, golden applicator 14.4/24.4 mm, ophthalmology applicator, isolated applicator L44/L64), at a safe distance from the patient's eyes.

	<p>The trained staff must make all possible precautions to protect eyes of the patient. Application must be performed at maximum peace, and all the other people that could distract the doctor during a complex procedure must be excluded. The trained operator takes all responsibility for not using the sharp tip close to the eyes contrary to the instructions acquired during the training.</p>
	<p><b>Patient-device connection</b></p> <p>Prior to start treatment, the patient must be connected with a disposable electrode pasted by the operator as close to the treated zone as possible and/or a cylinder electrode is used, it must be held by the patient firmly throughout the treatment; the patient's hand is gently moistened with a cloth for better conductivity before insertion of the cylinder electrode.</p>
	<p><b>Do not touch the tip</b></p> <p>Neither the operator nor the patient may touch the application tip during treatment. If the application tip ( is on) is moved away during treatment from the conductive gel layer – higher than ca 5 mm for the time period over 20 seconds, tip feeding will be interrupted ( is off). If the touch key  is held for 2 seconds, the spark discharge indicator starts to flash and the control electronics waits for start of the discharge for 60 minutes. Voltage on the tip will disappear within 1 second.</p>
	<p><b>Do not touch the patient</b></p> <p>The trained staff may not touch the patient conductively. If there is a need to touch the patient's skin, a non-conductive rubber glove has to be used.</p>
	<p><b>Before the first use and after each use, the applicator, the device, the Plasma Pen and the cylinder electrode must be cleaned and disinfected properly. When using the isolated applicators in natural body cavities, sterilization is required! Otherwise, there is a risk of infection!</b></p>
	<p><b>Ophthalmology applicator</b></p> <p>If the ophthalmology applicator is bent, it cannot be straightened any more.</p>
	<p><b>Side effects</b></p> <p>If treatment is performed on the faces of the patient having an amalgam seal, slight tingling in this area may occur. When treating the neck zone, there may be twitching movements due to a large number of nerve endings.</p>
	<p><b>Cleaning the device and the Plasma Pen</b></p> <p>Neither the device nor the Plasma Pen is waterproof. It may not be exposed to excessive moisture or liquid flow. <b>It is quite enough to disinfect the device body or the Plasma Pen with a damp cloth.</b></p>
	<p><b>Plasma Pen stand</b></p> <p>It is recommended to use the Stand 2 for the Plasma Pen to ensure stability and safety of the device during treatment.</p>

## 5. Device control

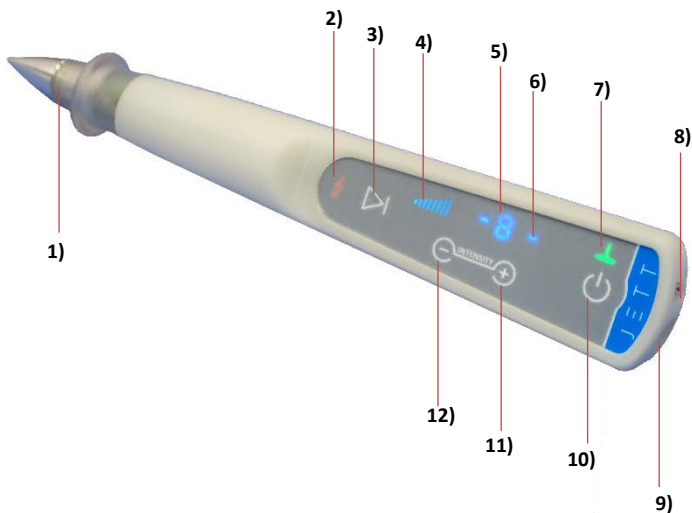

- 1) Exchangeable applicator, other applicators - see sec. 2.1 and 2.2;
- 2) Indicator of voltage on the tip;
- 3) Touch key Play/Pause (to connect the tip voltage ON and OFF);
- 4) Indicator of spark discharge efficiency (current going through the patient);
- 5) Indicator of spark discharge intensity (labelled "Intensity" on the display);
- 6) A dash before and after the number indicating intensity of the spark discharge;
- 7) Indicator of patient-device connection;
- 8) Socket for connection of curly connection cable for connection of the patient;
- 9) Socket for connection of the network adapter;
- 10) Touch key: device ON/OFF;
- 11) Touch key for setting a higher discharge intensity;
- 12) Touch key for setting a lower discharge intensity.

**Before every start of the device, check carefully condition and state of the supply adapter, power cable, disposable electrode or cylinder electrode with its connection cable, and condition of the device including its applicators. If you reveal any damage, do not switch the device on and contact the manufacturer!**

### a) **TAPE** calibration

Due to the different characteristics of electrical networks all over the world, the **TAPE** function may not work properly. To eliminate this problem, perform **TAPE** calibration by applying the following procedure that will allow to customize your device to your conditions:

- 1) Connect the JETT PLASMA LIFT MEDICAL device to the power supply source.
- 2) Connect the curly connection cable to the device.
- 3) Switch the device off, using the touch key .



- 4) At the same time hold the touch keys  and  for 3 seconds to be switched to the TAPE calibration mode.



- 5) Then you can see the changing characters on the display.
- 6) Hold the curly piece of the connection cable in your hand. In this case, the device recognizes the optimum " TAPE value".



Do not touch the metal end of the curly connection cable.



- 7) Press the touch key  to store the optimum „TAPE value“ in the internal memory.





This calibration can be repeated as needed, for example in case of each workplace change. The specified " TAPE value" should be stored within 30 seconds, otherwise the calibration mode will switched off automatically without storing the set value.

**b) Switching the device on**

Connect the adapter to the network 100-230 V, 50/60 Hz, and plug the adapter connector





into the power socket  of the JETT PLASMA LIFT MEDICAL device. The device will be switched on automatically and " TAPE " will be lighted on the display, indicating that the patient is not connected. Otherwise, the device is switched on by holding the touch key  for 5 seconds.

c) **Patient-device connection**



As soon as the patient is ready for treatment, it is necessary to ensure galvanic connection of the patient with the JETT PLASMA LIFT MEDICAL device, using the connection accessories:



- **cylinder electrode** – has to be held firmly in the hand;
- **disposable electrode** - it is necessary to clean the site before application; its use is recommended for one treatment only; store the unused electrodes in the original sealed packaging.



Plug the curly connection cable connector into the socket  ; the other end has to be fixed to the disposable electrode or into the cylinder electrode. The **TAPE** symbol disappears, the lowest intensity **- 1 -** is displayed and the  symbol will be lightened.



d) **Setting spark discharge intensity**





Change of the spark discharge intensity can be done only prior to pressing the touch key  and/or at the switched off .

After switching the device on, the default intensity **- 1 -** is set. Now, by pressing the touch key , intensity can be increased. Between the two dashes, the figures 2, 3, 4, 5 appear one by one on the display. These are the safe intensities that do not cause destruction of the skin cells. Decrease of safe intensities is performed by pressing the touch key .

As soon as you try to set the first dangerous intensity level **- 6 -** (able to destroy the cells) by pressing the touch key , the device sets the intensity level automatically to **- 0 -**, and the dashes before and after the numerical value of intensity start to blink. Now you have 6 seconds to set the dangerous intensity level to 6, 7 or 8. If the desired high intensity is not set within this short time period, the dashes will light up **- 6 -**, and the next pressing the touch key will result in their blinking again, and the intensity **- 0 -** will be set automatically.

e) **Switching on the high voltage source**

If you already set the spark discharge intensity, then, by pressing the touch key , you can connect high voltage to the device tip, and the control electronics waits 20 seconds for discharge ignition.  will go on.

If you hold the touch key  for 2 seconds,  will flash and the control electronics waits for start of discharge for 60 minutes. At flashing , it is impossible to change setting, only the touch key  responds.



f) **Spark discharge ignition**

As soon as the device or the Plasma Pen tip approaches the treated area (up to ca 2 mm), the spark discharge will be ignited. Otherwise the high voltage will be disconnected from the tip.

If the spark discharge is ignited and current passes through the patient, the holder will light or flash. This is not a defect, but a typical feature of the used component.

g) **Extinction of the spark discharge**

If you want to extinguish the spark discharge, press the touch key  or distract the applicator.

h) **Accelerated control when changing the dangerous intensities**

If we want to increase the intensity from 6 or 7, touch key  must be held for 2 seconds.

i) **Types of applicators and their use**

1) *flat applicators*

Flat applicators are used for non ablative treatment only (intensities 1-5), for wrinkles and rejuvenation. Flat applicators are designed for treatment of larger areas. These applicators move on skin covered with a conductive indifferent gel or serum, and the cells are stimulated electrically by DC current, i.e. Na/K channels are opened and the cell membranes depolarized afterwards.

2) *cone applicator*

Conical applicator is intended for precise non ablative treatment. Use is the same as for flat applicators, except that we use the cone applicator to precisely treat small areas of the skin (e.g. deep wrinkles).

3) *golden applicator*



It is designed to treat the skin with elimination of skin formations or to perform fulguration micro-burns on the skin near the wrinkles so that the skin may be stretched on the treated place, when healed completely.



4) *Head with isolated applicators*

Head with isolated applicators can be used for treatment of indications (see the chapter Indications) inside the natural body cavities without damage of the neighbourhood during the treatment.

### 5) Plasma Pen

Use of the Plasma Pen leads to improved and more adroit handling during treatment. The Plasma Pen is screwed instead of the applicator. If we already set the spark discharge intensity, then it is possible to activate high voltage connection to the

Plasma Pen, using the touch key . Pressing the Plasma Pen key will brought this voltage onto the tip of the applicator, and the control electronics waits for 20 seconds for discharge ignition. The spark discharge indicator  is on. If the discharge is not initiated, the electronics will disconnect high voltage from the tip.

If the touch key  is held for 2 seconds, the spark discharge indicator  flashed, and the control electronics waits for start of the discharge for 60 minutes. As soon as the tip of the device approaches up to 2 mm from the skin of the patient, the spark discharge will be ignited.

Replacement of applicators can be performed by pushing the head towards the Plasma Pen body and then by pulling the existing applicator out. The selected applicator is simply pushed into the Plasma Pen head. Perform replacement at switched off device only.

#### a) flat applicators

Flat applicators are used for non ablative treatment only (intensities 1-5), for wrinkles and rejuvenation. Flat applicators are designed for treatment of larger areas. These applicators move on skin covered with a conductive indifferent gel or serum, and the cells are stimulated electrically by DC current, i.e. Na/K channels are opened and the cell membranes depolarized afterwards.

#### b) cone applicator

Conical applicator is intended for precise non ablative treatment. Use is the same as for flat applicators, except that we use the cone applicator to precisely treat small areas of the skin (e.g. deep wrinkles).

#### c) golden applicators 14.4 and 24.4 mm

Are designed to treat the skin with precise elimination of skin formations or to perform fulguration micro-burns on the skin near the wrinkles so that the skin may be stretched on the treated place, when healed comp.



d) ophthalmology applicator

The applicator can be used for treatment of the anterior, posterior eyelid and the ocular mucosa where the thermal effect of the spark discharge leads, for example, to increase in viscosity of the connective tissues round the glands and their outlets, to stimulation of impervious tear ducts and thus better tear drainage, to destruction of eyelash follicles that penetrate into the eye and irritate it unpleasantly, or to recovery of the original state and to fat cells dissolving. If the ophthalmology applicator is bent, it cannot be straightened any more.

e) isolated applicators L44 and L64

The applicators can be used for treatment of indications (see the chapter Indications) inside the natural body cavities without damage of the neighbourhood during the treatment.













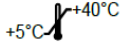

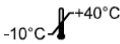

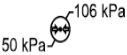
j) **Ending the treatment**

The procedure can be ended at any time by pressing the key , but also by removing the applicator from the treated skin for the time period longer than 20 seconds. In this case, the device is paused automatically and the treatment can be resumed by pressing the touch key . If the touch key  is held for 2 seconds, the device will be suspended automatically after 60 minutes.

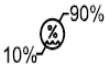
k) **Switching off the device**

After completing the procedure, turn off the device by holding the touch key , then disconnect the device from the power supply source.

## 5.1 Symbols on the cover of the device, on the device itself and on accessories

Graphic symbol	Meaning	Graphic symbol	Meaning
	Warning from possible danger /risk, follow instructions in the Instruction for Use.		Galvanic connection with the device
	Manufacturer		Temperature range for use of the device, min. temperature +5°C max. temperature +40°C
	Serial number		Temperature range for storage and transportation of the device, min. temperature -10°C, max. temperature +40°C
	Lot (batch)		Pressure range, min. 50 kPa, max. 106 kPa
	Applicator of the BF type		Restriction of humidity for use of the device, min. 30 %, max. 70 %.
	Electric waste (after expiry of the service life of the device) may not be disposed of together with the municipal waste.		Restriction of humidity for storage and transportation of the device, min. 10 %, max. 90 %.
	Device of the class of protections II.		Protect from rain.
	Use indoors.		Designation of the socket for connection of the network adapter
	Protection from a lightning.		

## 6. Basic characteristics

Class of protection against electric shock	II
Device type model	with the applied part of BF type
Type of power supply source	ACM18US05
Power supply source input	100–240 VAC, 50/60 Hz
Power supply source output	5 VDC, max. 2,5 A
Power supply consumption	max. 15 VA
Spark discharge generator voltage	5.5 kV
Spark discharge intensity	1.8 W
Detection of correct patient connection	SCS system
Automatic HV switching off on the tip:	after 20 s and/or after 60 minutes, when set so
Accelerated voltage reduction on the tip up to zero after device switching off	after 1 s
Dimensions	length 245 mm, width 45 mm
Weight	ca 350 g
Relative air humidity range:	30–70 %
Ambient temperature range	+5°C to +40°C
Atmospheric pressure range	50–106 kPa
Working environment	with respect to the basic function of the device - to generate the spark discharge, the device may not be used in an environment where any combustible gases may be present, either in the primary form of gas or as fumes of flammable substances
Class of protection	IP20
Storage conditions	store in the original package indoors, on a dry place with the temperature ranging from -10°C to +40°C and relative air humidity of 10–90 %
Transportation	transportation in the original package in a sheltered transportation vehicle, at the temperature of -10°C up to +40°C and relative humidity of 10–90 %, without condensing; atmospheric pressure range 50–106 kPa

## 7. Service life

Device	10 years
Network adapter	10 years
Plasma Pen	2 years
Flat applicator	2 years
Golden applicator	2 years
Conical applicators	2 years
Flat applicator, diameter 3 mm	2 years
Flat applicator, diameter 5 mm	2 years
Conical applicator for Plasma Pen	2 years
Flat applicator, diameter 3 mm Plasma Pen	2 years
Flat applicator, diameter 5 mm Plasma Pen	2 years
Flat applicator, diameter 10 mm Plasma Pen	2 years
Flat applicator, diameter 20 mm Plasma Pen	2 years
Golden applicator 14.4 mm Plasma Pen	2 years
Golden applicator 24.4 mm Plasma Pen	2 years
Cylindrical electrode	2 years
Head with isolated applicator L44	2 years
Head with isolated applicator L64	2 years
Head with isolated applicator L84	2 years
Extension cable	2 years
Ophthalmology applicator Plasma Pen	3 months
Isolated applicator L44 Plasma Pen	2 years
Isolated applicator L64 Plasma Pen	2 years
Curly connection cable for disposable electrode	1 year
Curly connection cable for cylinder electrode	1 year
Disposable electrodes	set by the manufacturer
Stand 1	10 years
Stand 2	10 years

Service life of the device and its accessories is calculated from the date of delivery. However, this does not apply to the disposable electrodes, service life of which has already been set by the manufacturer.

**Any modification of the medical device JETT PLASMA LIFT MEDICAL is strictly forbidden!!!**

## 8. Storage, maintenance and safety technical inspections

### 8.1 Storage

- Ideal storage temperature:  $-10^{\circ}\text{C}$  up to  $+40^{\circ}\text{C}$ ;
- Store the device indoors, in a well-ventilated room, protected from direct sunlight and humidity;
- store the device unplugged from the el. power source.

### 8.2 Regular maintenance and cleaning

- Maintenance - the operator is obliged to observe all provisions of the Instruction for Use. It is not permitted to interfere with the device, all maintenance operations have to be performed by the manufacturer within the scope of the annual inspections.

- The applicators have to be disinfected before the first use and after each application, using standard disinfectants (see sec. 8.2.1)! It is enough to disinfect body of the device with a damp cloth. It does not apply to the isolated applicators and their heads used inside the natural body cavities - they **must be sterilized** (see sec. 8.2.2)!

### 8.2.1 Disinfection

Before the first use and after each treatment, thorough disinfection of the used applicator, cylinder electrode, device and the Plasma Pen must be performed, using one of the following disinfectants:

- CUTASEPT F;
- SEKUSEPT EXTRA N;
- SEKUSEPT PLUS.

The applicator and the cylinder electrode are only wiped thoroughly. Body of the device and the Plasma Pen are disinfected by a wetted cloth. **Disinfectants have to be changed!**

### 8.2.2 Sterilization

Heads with isolated applicators and the isolated applicators themselves are intended for treatment inside natural body cavities and therefore they have to be sterilized as follows:

- A. KORSOFLEX plus – cleaning and disinfection.
- B. Ten rinses as a minimum.
- C. Steam sterilization at 134°C for 7 minutes. Heads with isolated applicators and the isolated applicators themselves have the character of a hollow tool. This is a standard complexity of a cavity - it is necessary to use the sterilizers with the standard complexity of a cavity.

**Sterilization is performed before the first use and after each application.**

### 8.3 Safety technical inspections

If safety technical inspections (STI) are requested by national regulations, they should be performed once a year. STI must be performed only by the service staff of the manufacturer or by an authorized service centre. If the safety inspection was not performed within the preset term by the manufacturer or an authorized service organization, the device may not be used until the STI is done.

Service, maintenance or the preset STI of the device may not be used during treatment of a patient.

### 8.4 Product retirement and disposal



The waste consisting of electrical or electronic devices can contain dangerous substances that may be harmful for the environment or human health. The JETT PLASMA LIFT MEDICAL device is included in the group of electric waste and after expiry of its service life, it may not be disposed of with the municipal waste.

## 9. Servicing

Warranty and after-warranty servicing is performed by the manufacturer:

COMPEX, spol. s r.o.  
Palackého třída 924/105  
612 00 Brno  
e-mail: info@jett.eu

In case of a fault or malfunction, send the device to the manufacturer with the duly filled-in Complaint Protocol, being the integral part of this Instruction for Use, and with the adapter, extension cable for the adapter and with the curly connection cables to the above address. If the accessories as above are not delivered, the used accessories will be charged to you.

As soon as the complaint is settled, the manufacturer's statement will be mailed to you electronically, and the repaired device will be delivered to your billing address or to your delivery address.

## 10. Warranty

This product is covered by the warranty encompassing material imperfections and production faults for the time period of one year after delivery of the device and/or for further 12 months, if the STI has been performed by the manufacturer or the authorized service centre after the first year of use. The product has been sealed and the warranty ceases to exist if the seal/protection is damaged.

The manufacturer undertakes, depending on his possibilities, to repair the device or to replace its damaged parts for the whole term of the warranty, provided that these repairs or replacements are performed directly by the manufacturer or by his authorized representatives.

The manufacturer takes responsibility for safety, reliability and performance /effectiveness of the device only if all repairs, replacements or alterations of the product are performed by the authorized staff, if the device was used in accordance with this Instruction for Use, if the parameters of electric network (in the room where the device is plugged) satisfy all the requirements set by law.

If the product is sent back to the manufacturer, the user shall pay the transportation costs.

## 11. EMC

### 11.1 Electromagnetic interference

The JETT PLASMA LIFT MEDICAL device is intended for use in the environment of the home health care and is classified as Class B according to ČSN EN 55011 ed. 4: 2017 + A1: 2017. It may not be used in the vicinity of active HF equipment and in the RF shielded room with the medical systems for magnetic resonance imaging, where intensity of EM disturbances is high.

Any loss or deterioration of the JETT PLASMA LIFT MEDICAL device function due to electromagnetic interference is not understood unacceptable risk to the patient or the operator. There is no need to adopt any measures or actions to avoid adverse events for the patient or for the operator due to electromagnetic interference.

**WARNING:** Use of the JETT PLASMA LIFT MEDICAL device in the vicinity of or linked with other devices can result in incorrect operation. If such use is necessary, this device and other devices



must be monitored to verify normal correct function.

**WARNING:** The JETT PLASMA LIFT MEDICAL device may be used with the delivered connection cables only. Use of the connection cables other than the delivered ones may result in non-fulfilment of the requirements for radiation or resistance of the device.

**WARNING:** Only the delivered power supply source ACM18US05, manufactured by XP Power, may be used for feeding the JETT PLASMA LIFT MEDICAL device.

**WARNING:** Do not use a portable radio-communication device (incl. the end devices such as antenna cables and external antennas) at the distance closer than 30 cm (12 inches) from any part of the JETT PLASMA LIFT MEDICAL device, incl. the connection cables. Otherwise, its functionality may be deteriorated.

### 11.2 Electromagnetic emissions

The JETT PLASMA LIFT MEDICAL device meets requirements of ČSN EN 55011 ed. 4:2017+A1:2017 for the lead-through emission limits, emitted for the Group 1, Class B.

Frequency band of 0.15–0.50 MHz:

- The quasi-peak value does not exceed 66 dB ( $\mu\text{V}$ ), falls linearly with the frequency logarithm to 56 dB ( $\mu\text{V}$ );
- The mean value does not exceed 56 dB ( $\mu\text{V}$ ), falls linearly with the frequency logarithm to 46 dB ( $\mu\text{V}$ ).

Frequency band of 0.50–5 MHz:

- The quasi-peak value does not exceed 56 dB ( $\mu\text{V}$ );
- The mean value does not exceed 46 dB ( $\mu\text{V}$ ).

Frequency band of 5–30 MHz:

- The quasi-peak value does not exceed 60 dB ( $\mu\text{V}$ );
- The mean value does not exceed 50 dB ( $\mu\text{V}$ ).

Frequency band of 23–230 MHz:

- The quasi-peak value does not exceed 42 dB ( $\mu\text{V}/\text{m}$ ), falls linearly with the frequency logarithm to 35 dB ( $\mu\text{V}/\text{m}$ )

Frequency band of 230–1000 MHz:

- The quasi-peak value does not exceed 42 dB ( $\mu\text{V}/\text{m}$ ).

The JETT PLASMA LIFT MEDICAL device meets the requirements of CSN EN 61000-3-2 ed. 4: 2015 to limit harmonic currents injected into the public grid for Class A.

JETT PLASMA LIFT MEDICAL II device meets the requirements of CSN EN 61000-3-3 ed.3:2014 to limit voltage changes, voltage fluctuations and flicker in the low-voltage distribution networks for the devices with a rated phase current  $\leq 16$  A not subject to conditional connection.

### 11.3 Electromagnetic immunity

The JETT PLASMA LIFT MEDICAL device meets the requirements for electromagnetic immunity in conformity with the standards shown below:

CSN EN 61000-4-2 ed. 2:2009, test immunity level, electrostatic discharge (ESD):

- $\pm 8\text{kV}$  for contact discharge;
- $\pm 2, \pm 4, \pm 8\text{kV}, \pm 15\text{kV}$  for air discharge.

CSN EN 61000-4-3 ed. 3:2006+A1:2008+Z1:2010+A2:2011, test immunity level, irradiated high frequency:

- $10\text{ V/m}$ , 80 MHz up to 2.7 GHz;
- 80 % AM at 1 kHz.

CSN EN 61000-4-4 ed. 3:2013, test immunity level, quick electrical transient phenomenon / pulse groups:

- $\pm 2\text{kV}$ , repetition frequency of 100 kHz.

CSN EN 61000-4-5 ed. 3:2015, test immunity level, shock coupled pulse:

- $\pm 1\text{kV}$  between the lines;
- $\pm 2\text{kV}$  between the line(s) and the ground.

CSN EN 61000-4-6 ed. 4:2014, test immunity level, irradiated high frequency:

- 3 V, 150 kHz up to 80 MHz;
- 6 V, 150 kHz up to 80 MHz, 80 %AM at 1 kHz.

high-frequency line:

- $3\text{ V/m}$  80 MHz up to 2.5 GHz.

CSN EN 61000-4-8 ed. 2:2010, test level, network frequency magnetic field (50/60 Hz):

- 30 A/m 50 or 60 HZ.

CSN EN 61000-4-11 ed. 2:2005, test level, short-term voltage drops,













- 0 %  $U_T$  in 0.5 cycle at  $0^\circ, 45^\circ, 90^\circ, 135^\circ, 180^\circ, 225^\circ, 270^\circ, 315^\circ$ ;
- 0 %  $U_T$ , 1 cycle;
- 70 %  $U_T$ , 25/30 cycles;
- Single phase: at  $0^\circ$ .

test level – Vltav breaking:





































- 0 %  $U_T$ , 250/300 cycles.































The standards have been used without any deviations.



## 12. Rating plate of the device



	COMPEX, spol. s r.o. Palackého třída 924/105 Brno CZ info@jett.eu www.jett.eu
<b>JETT PLASMA LIFT MEDICAL</b>	
 SN	0174/18  0123   
 $+5^\circ\text{C}$  $+40^\circ\text{C}$	 106 kPa  50 kPa  70%  30%
Input voltage:	5 VDC/max 2,5 A
Input power:	15 VA



### 13. Rating plate of accessories

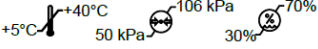

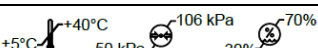

	COMPEX, spol. s r.o. Palackého třída 924/105 Brno CZ info@jett.eu www.jett.eu
<b>Flat applicator</b>	
<b>LOT</b>	T031801 <span style="float: right;">CE 0123 </span>
	+5°C  +40°C 50 kPa  106 kPa  70% 30%
	COMPEX, spol. s r.o. Palackého třída 924/105 Brno CZ info@jett.eu www.jett.eu
<b>Golden applicator</b>	
<b>LOT</b>	T061801 <span style="float: right;">CE 0123 </span>
	+5°C  +40°C 50 kPa  106 kPa  70% 30%
	COMPEX, spol. s r.o. Palackého třída 924/105 Brno CZ info@jett.eu www.jett.eu
<b>Cone applicator</b>	
<b>LOT</b>	T021801 <span style="float: right;">CE </span>
	+5°C  +40°C 50 kPa  106 kPa  70% 30%
	COMPEX, spol. s r.o. Palackého třída 924/105 Brno CZ info@jett.eu www.jett.eu
<b>Flat applicator, diameter 3 mm</b>	
<b>LOT</b>	T051801 <span style="float: right;">CE </span>
	+5°C  +40°C 50 kPa  106 kPa  70% 30%
	COMPEX, spol. s r. o. Palackého třída 924/105 Brno CZ info@jett.eu www.jett.eu
<b>Flat applicator, diameter 5 mm</b>	
<b>LOT</b>	T041801 <span style="float: right;">CE </span>
	+5°C  +40°C 50 kPa  106 kPa  70% 30%
	COMPEX, spol. s r.o. Palackého třída 924/105 Brno CZ info@jett.eu www.jett.eu
<b>Head with isolated applicator L44</b>	
<b>LOT</b>	T221801 <span style="float: right;">CE 0123 </span>
	+5°C  +40°C 50 kPa  106 kPa  70% 30%

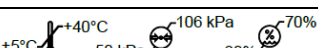

	COMPEX, spol. s r.o. Palackého třída 924/105 Brno CZ info@jett.eu www.jett.eu
<b>Head with isolated applicator L64</b>	
<b>LOT</b>	T231801 <span style="float: right;">CE 0123 </span>
	+5°C  +40°C 50 kPa  106 kPa  70% 30%
	COMPEX, spol. s r.o. Palackého třída 924/105 Brno CZ info@jett.eu www.jett.eu
<b>Head with isolated applicator L84</b>	
<b>LOT</b>	T241801 <span style="float: right;">CE 0123 </span>
	+5°C  +40°C 50 kPa  106 kPa  70% 30%
	COMPEX, spol. s r.o. Palackého třída 924/105 Brno CZ info@jett.eu www.jett.eu
<b>Cylinder electrode</b>	
<b>LOT</b>	T011801 <span style="float: right;">CE 0123 </span>
	+5°C  +40°C 50 kPa  106 kPa  70% 30%
	COMPEX, spol. s r.o. Palackého třída 924/105 Brno CZ info@jett.eu www.jett.eu
<b>Curly connection cable for cylinder electrode</b>	
<b>LOT</b>	20180101 <span style="float: right;">CE 0123 </span>
	+5°C  +40°C 50 kPa  106 kPa  70% 30%
	COMPEX, spol. s r.o. Palackého třída 924/105 Brno CZ info@jett.eu www.jett.eu
<b>Curly connection cable for disposable electrode</b>	
<b>LOT</b>	20180101 <span style="float: right;">CE 0123 </span>
	+5°C  +40°C 50 kPa  106 kPa  70% 30%



	COMPEX, spol. s r.o. Palackého třída 924/105 Brno CZ info@jett.eu www.jett.eu
<b>Extension cable for the network adapter</b>	
<b>LOT</b>	20180101  
	

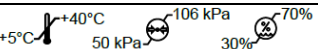

	COMPEX, spol. s r.o. Palackého třída 924/105 Brno CZ info@jett.eu www.jett.eu
<b>Stand 1</b>	
<b>LOT</b>	20180101  
	

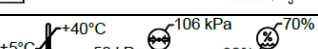

	COMPEX, spol. s r.o. Palackého třída 924/105 Brno CZ info@jett.eu www.jett.eu
<b>Stand 2</b>	
<b>LOT</b>	20180101  
	

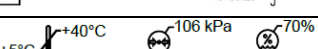

	COMPEX, spol. s r.o. Palackého třída 924/105 Brno CZ info@jett.eu www.jett.eu
<b>Plasma Pen</b>	
<b>SN</b>	PEN 0001/18   
	

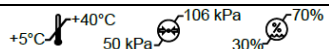

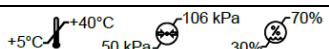

	COMPEX, spol. s r.o. Palackého třída 924/105 Brno CZ info@jett.eu www.jett.eu
<b>Golden applicator 14.4 mm Plasma Pen</b>	
<b>LOT</b>	T111801  
	



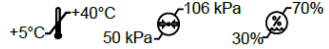

	COMPEX, spol. s r.o. Palackého třída 924/105 Brno CZ info@jett.eu www.jett.eu
<b>Golden applicator 24.4 mm Plasma Pen</b>	
<b>LOT</b>	T121801  
	



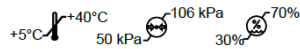

	COMPEX, spol. s r.o. Palackého třída 924/105 Brno CZ info@jett.eu www.jett.eu
<b>Isolated applicator L44 mm Plasma Pen</b>	
<b>LOT</b>	T191801  
	



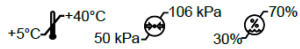





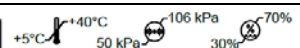

	COMPEX, spol. s r.o. Palackého třída 924/105 Brno CZ info@jett.eu www.jett.eu
<b>Isolated applicator L64 mm Plasma Pen</b>	
<b>LOT</b>	T201801  
	











	COMPEX, spol. s r.o. Palackého třída 924/105 Brno CZ info@jett.eu www.jett.eu
<b>Ophthalmology applicator Plasma Pen</b>	
<b>SN</b>	0001/18  
	

	COMPEX, spol. s r.o. Palackého třída 924/105 Brno CZ info@jett.eu www.jett.eu
<b>Cone applicator Plasma Pen</b>	
<b>LOT</b>	T131801  
 	

	COMPEX, spol. s r.o. Palackého třída 924/105 Brno CZ info@jett.eu www.jett.eu
<b>Flat applicator, diameter 3 mm, Plasma Pen</b>	
<b>LOT</b>	T171801  
 	

	COMPEX, spol. s r.o. Palackého třída 924/105 Brno CZ info@jett.eu www.jett.eu
<b>Flat applicator, diameter 5 mm, Plasma Pen</b>	
<b>LOT</b>	T161801  
 	

 COMPEX, spol. s r.o. Palackého třída 924/105 Brno CZ info@jett.eu www.jett.eu	
<b>Flat applicator, diameter 10 mm, Plasma Pen</b>	
 T151801	CE  
	 +5°C -  +40°C  50 kPa -  106 kPa  30% -  70%

 COMPEX, spol. s r.o. Palackého třída 924/105 Brno CZ info@jett.eu www.jett.eu	
<b>Flat applicator, diameter 20 mm, Plasma Pen</b>	
 T141801	CE  
	 +5°C -  +40°C  50 kPa -  106 kPa  30% -  70%

14. List of Annexes  
Complaint Protocol

# ***Complaint protocol JETT PLASMA LIFT MEDICAL***

*Filled in by the claimant*

<b>Manufacturer</b>	COMPEX, spol. s r.o.	
	<b>Address</b>	Palackého třída 924/105, 612 00 Brno Česká republika/Czech Republic
	<b>E-mail:</b>	info@jett.eu
<b>**Claimant (company, contact person, phone, e-mail)</b>	<b>**Invoice address</b>	
	<b>**Delivery address, if it is different than invoice address</b>	
<b>**No. and date of invoice issuance</b>		
<b>**Date of detection</b>		
<b>**Serial number</b>		
<b>**Detailed description of the defect</b>		
<b>**Package contents upon delivery*</b>		
<b>**Date of the claim</b>		

## ***Complaint protocol JETT PLASMA LIFT MEDICAL***

---

**\*\*Claimant's  
signature and stamp**

\*Claimed goods always deliver with the AC adapter, the connection cable to the AC adapter and curly connection cables to prevent any extension of the complaint and increase in cost.

**\*\*Obligatory field**